

M8 female 0° A-cod. with cable

PVC 4x0.34 gy CEI 3m

Female straight

M8, 4-pole

Art-No. 7005 - M8 Lite - (plastic hexagonal screw) on request with cable sleeves

⚠ NOTICE ⚠

Plastic housings with good resistance against chemicals and oils.

The resistance to aggressive media should be individually tested for your application. Further details on request.

PRODUCT WILL BE DISCONTINUED BY SEP. 2023. PLEASE HAVE A LOOK AT THE ALTERNATIVE PRODUCTS.

Further cable lengths on request.

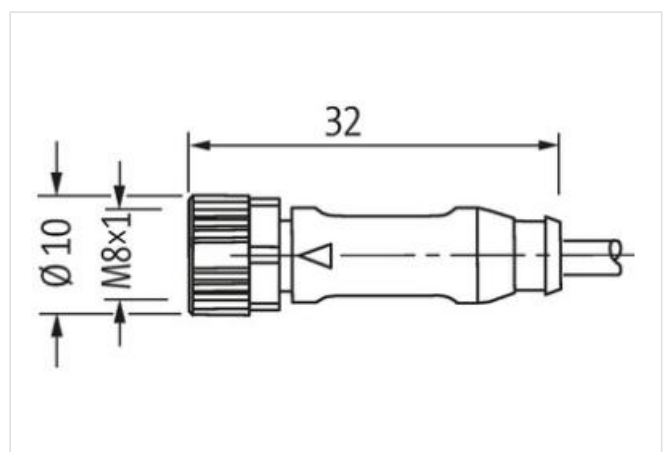
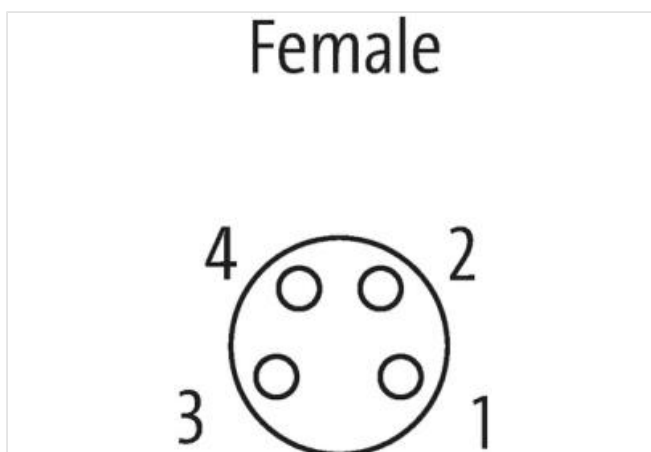
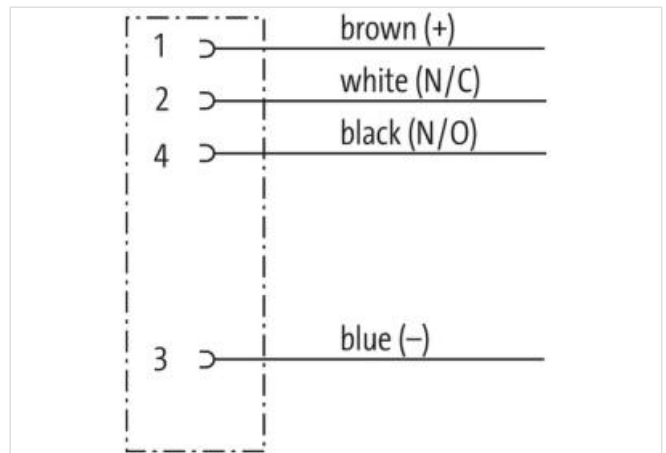
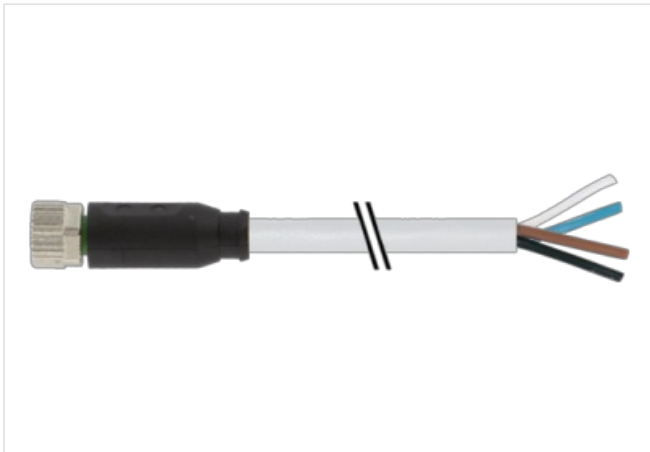
[Link to Product](#)**Illustration**

Product may differ from Image



Cable length 3 m

Technical Data

Operating voltage	max. 50 V AC/60 V DC
Rated surge voltage	1.5 kV
Operating current per contact	max. 4 A
No. of poles	4
Material group	IEC 60664-1, category I
LED display	no
Locking of ports	Screw thread (M8×1 mm) recommended torque 0.4 Nm, self-securing
Protection	IP65, IP66K, IP67 inserted and tightened (EN 60529)
Material	PUR
Locking material	Zinc die casting, matte nickel plated
suitable for corrugated tube (internal Ø)	6.5 mm
Compression gland	M8 (SW9)

General data

Standards	DIN EN 61076-2-104 (M8)
Mounting method	inserted, tightened
Material contact	Copper alloy
Material contact surface	Au
Material gasket	FKM
Pollution Degree	3
Stripping length (jacket)	20 mm
Temperature range	-25...+85 °C, depending on cable quality

Cable

No./diameter of wires	4× 0.34 mm ²
Wire isolation	PVC (br, wh, bl, bk)
Outer Ø	5.0 mm ±5%
Cable number	324
Color jacket	gray
Jacket Color	gray
Temperature range (fixed)	-30...+80 °C
Temperature range (mobile)	-10...+80 °C
Bend radius (fixed)	5× outer Ø
Bend radius (moving)	10× outer Ø
Material jacket	PVC (CEI 20-22)