

# INSTALLATION SCHEMATIC

## PHOTOVOLTAIC PLANT INTO THE MAIN CIRCUIT BREAKER

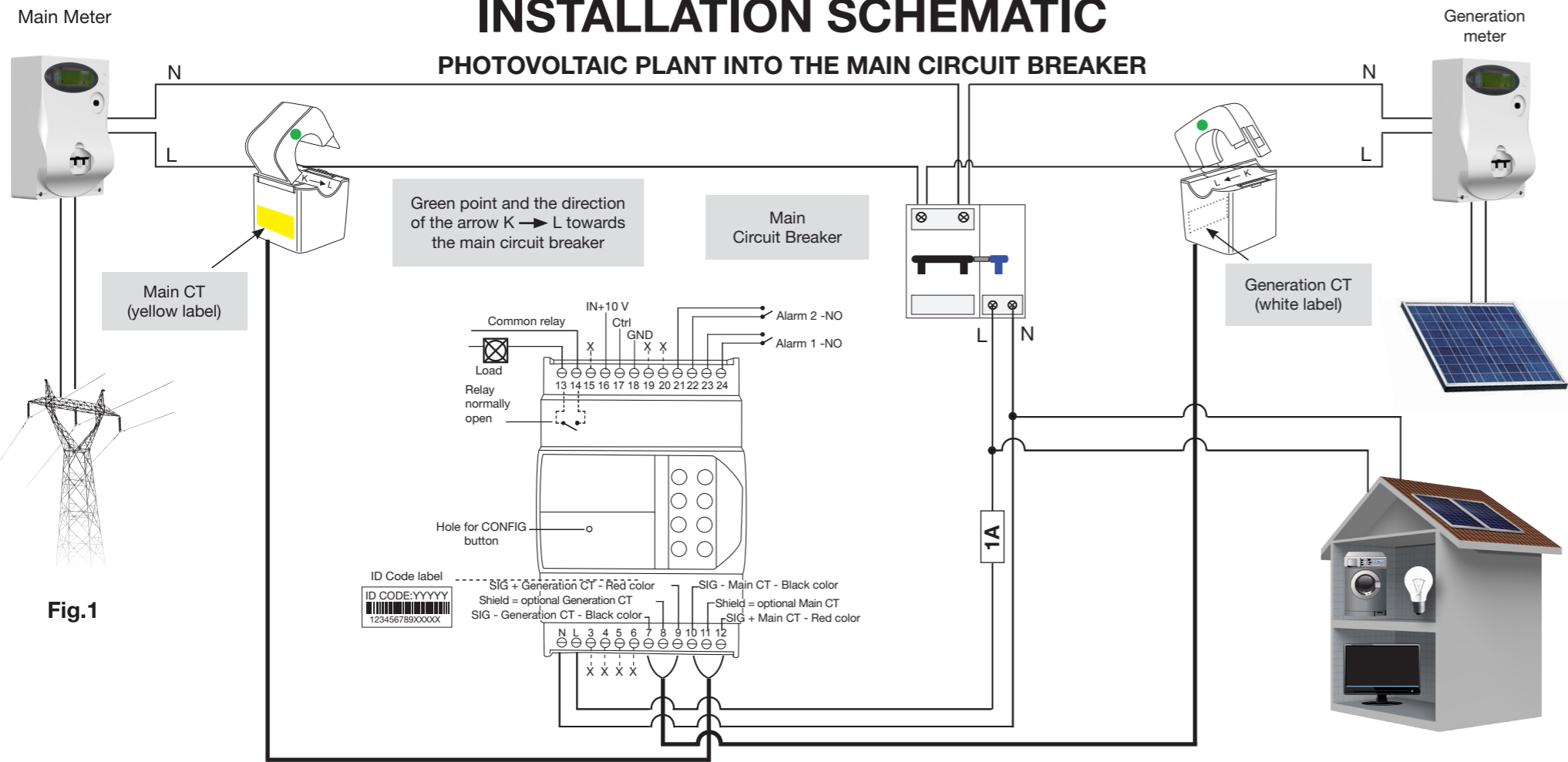

Fig.1

## PHOTOVOLTAIC PLANT DIRECTLY WIRED INTO THE MAINS METER

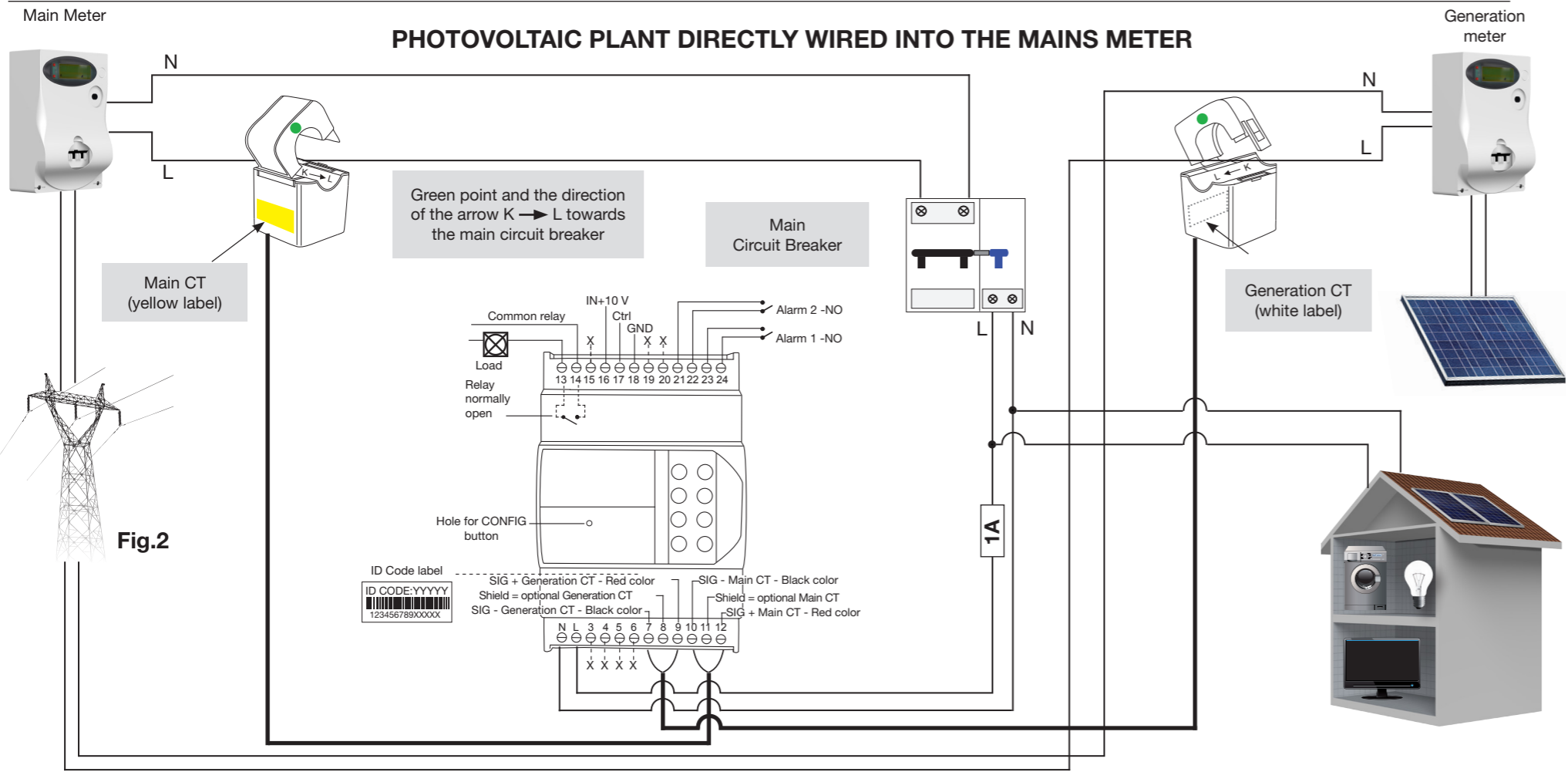
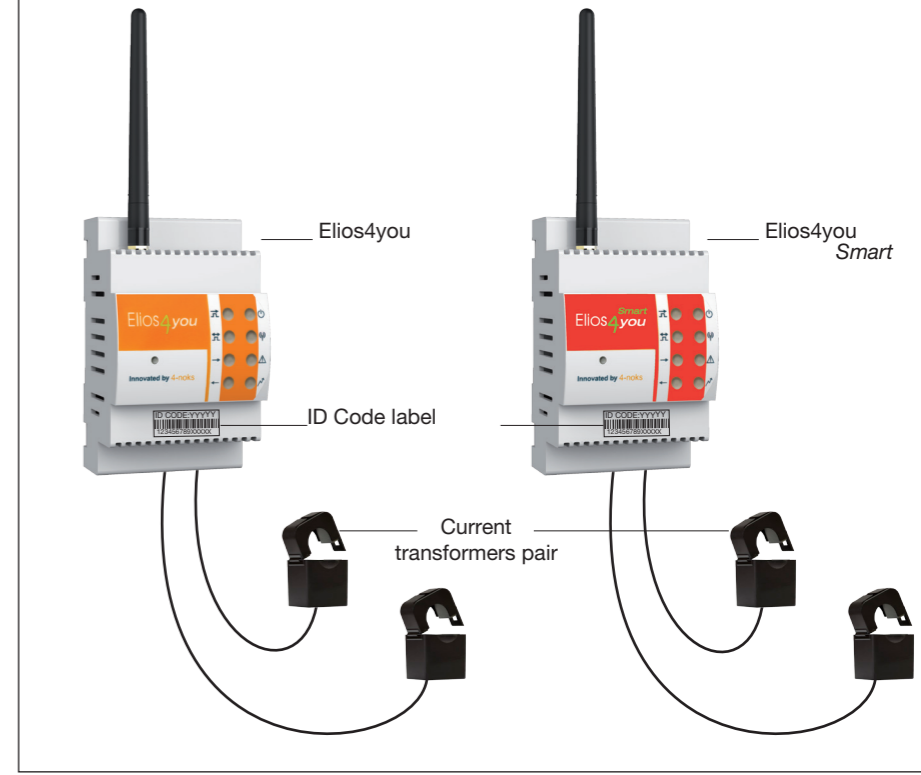

Fig.2

# ELIOS4YOU & ELIOS4YOU SMART

## Quick Guide

The Elios4you family of products are wireless devices designed to monitor and manage single-phase photovoltaic installations via the Elios4you APP. Maximum monitored power 10kW. The transmitter measures the energy generated of the PV plant, exchanged with the grid, the household consumption and the self-consumption. In the "Smart" version it allows to optimize the self-consumption by turning programmed loads with additional Plug and Switch accessories.



READ AND KEEP THESE INSTRUCTIONS FOR REFERENCE



**ATTENTION:** Installation must be completed by qualified personnel only. The customer (builder, developer or installer) accepts all liability and risk relating to the configuration of the product to achieve the expected results in relation to the specific installation. Any deficiencies in the acknowledgment of the instructions may lead to malfunctions and / or damage to the devices, to which 4-NOKS cannot be held responsible. The responsibility of 4-NOKS in relation to the devices manufactured is regulated by the general terms & conditions. Be careful to ensure all works being carried out are completed by qualified personnel, during which, no power is being supplied to the devices.

Product identification:  
this document refers to following devices:

Code	Device
E4U	Elios4you
E4U-S	Elios4youSmart

**CE** All models are compliant to directive 2004/108 CE - 2006/95 CE - directive 99/5 CEE

The appliance (or the product) must be disposed of separately in accordance with the local regulations regarding disposal.

4-NOKS hereby declares that these products conform to the essential requirements and to all relevant specifications established by Directive 1999/5/CE. The declaration of conformity may be consulted on the website: [www.4-noks.com](http://www.4-noks.com).

Innovated by 4-noks

4-noks SRL - Via Per Sacile, 158 - Francenigo di Gaiarine (TV) - Italy  
Tel. +39 0434 768462 - Fax +39 0438 694617 - info@4-noks.com - www.4-noks.com

+057408021R1.3 - E4U - E4U-S Quick Guide EN 15/06/2015



## ATTENTION

**ATTENTION:** in order to protect against overvoltages and short circuits, the device must be powered via an easily accessible and externally located sectioning breaker, thermal magnetic breaker or 230 Vac 1 A fuse.

**ATTENTION:** Before installing Elios4you, remove the label with device credentials and attach below (or keep in a safe place) for future reference and/or monitoring via the 4-Cloud Dashboard (web-portal) [www.4-cloud.org](http://www.4-cloud.org)

**ID CODE: 00000**  
Register on:  
[www.4-cloud.org](http://www.4-cloud.org)  
and associate your device  
with USER: XXXXXXXX

**ATTENTION:** If you are configuring the Elios4you APP via the Router/AP, data will be visible via the 4-Cloud Dashboard after approximately 1 hour from configuration.



## ATTENTION





**WARNING:** if the generation energy LED  does not blink when the PV installation is producing energy, it is necessary to invert the Generation CT orientation by swapping the connection of the wires of Elios4You (terminals 7 and 9).

**WARNING:** if the LEDS  detect the wrong energy flow ("sold" energy when it should report a situation of "purchased" energy or vice versa), it is necessary to invert the mains CT (yellow label) by swapping the connection of the wires of Elios4You (terminals 10 and 12).

**WARNING:** Ensure that the positioning of the Generation & Mains CTs are correct to the wiring of the property. Otherwise the resulting measurements may not be reliable. Ensure the Mains CT clamp is positioned after the Mains Meter, but before the Consumer Unit. Taking into account any Henley Blocks / Split Junctions.

**WARNING:** Alterations to the length of CT cables may cause increases in marginal errors during measurements. We do not recommend such alterations of the device.

## INSTALLATION

- Secure the device on a DIN rail, following the connections showed in the previous scheme (Fig.1 and Fig. 2).
- Once the device is installed and powered on, download the free Elios4you APP on your own smart device (smartphone or tablet) from **Playstore** (Android) or **App Store** (iOS)
- Open the App and start the Wizard Configuration, following the steps visible on your smartphone/tablet (read the Elios4you APP Quick Guide for further information)
- Set correct parameters for your PV system and your energy provider using the App menu:
  - Press  "Menu" button
  - Select  "Parameter Settings"
  - Select "Energy Management" and set values
  - Press OK when finished to save new values.
- Ensure the data values are correct:
  - Press  "Home" button to go to the "Energy Performance" page
  - Check that energy "Generation" value  has a similar value to that from the inverter
  - Check that the energy "Consumption"  value relative to the real-time consumption you have in the property.

**ATTENTION:** Configuring Elios4you in "Indirect Mode" grants access through the broadband Router/AP, allowing all data to be sent to the 4-Cloud, visible remotely through the Elios4you APP (when 4-Cloud is activated) and also via the 4-Cloud Dashboard (web-portal). Go to <http://www.4-cloud.org> and follow the instructions to register your device. Using the credentials on the label provided (see left).

### Elios4you Front Panel Icons

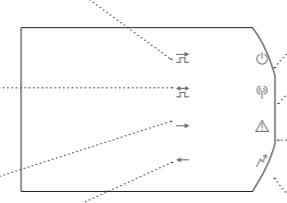
Blink frequency proportional to the amount of generated energy of the pv plant	(red)		Power supply	(green)
Blink frequency proportional to the amount of energy exchanged with the grid	(red)		Wi-Fi on	(green)
If ON: energy currently being purchased from the grid	(red)		General alarm or failed attempt to get connected to the smart device	(red)
If ON: energy currently being sold to the grid	(green)		Not used	(green)

## TROUBLESHOOT

Problem	Solutions
1. I can't see my PV system energy generation in the App's Home Page	a. Change the Generation CT clamp (white label) orientation, by inverting the green dot (or the arrow direction inside the clamp) to the opposite direction. b. Check that the Generation CT clamp (white label) is only clamped around the PV Live cable (not including the Neutral cable). c. Check that the CT clamp core is not broken or cracked inside (you may hear a buzzing noise). d. Check that the Generation CT clamp (white label) is properly closed - be sure not to apply excessive force.
2. The energy generation visible on the App is definitely less than the value read from the inverter	a. Ensure that the Elios4you transmitter is powered from the same Live phase as the Mains CT clamp (yellow label). b. Check that the Generation CT clamp (white label) is properly closed - be sure not to apply excessive force.
3. The Consumption line has the same shape as the Generation line in the graph	a. Ensure that the Mains CT clamp (yellow label) is clamped over the Mains Live phase cable after the Mains Meter and before the Consumer Unit and/or any Henley Block. Failing to do so will not give an accurate measure of total consumption. b. Ensure that the Neutral cable is not included within the Generation / Mains CT clamps. c. Check that the CT clamp cores are not broken or cracked inside (you may hear a buzzing noise).
4. It seems that the Consumption values are only being shown in the "Grid" icon	a. Ensure that the Mains CT clamp (yellow label) is clamped over the Mains Live phase cable after the Mains Meter and before the Consumer Unit and/or any Henley Block. Failing to do so will not give an accurate measure of total consumption.
5. I can never see "Purchased Energy" in my system	a. Ensure that the Mains CT clamp (yellow label) is clamped over the Mains Live phase cable after the Mains Meter and before the Consumer Unit and/or any Henley Block. Failing to do so will not give an accurate measure of total consumption.
6. During the night the consumption is zero, while during the day consumption is always more than the expected value	a. Change the Mains CT clamp (yellow label) orientation, by inverting the green dot (or the arrow direction inside the clamp) to the opposite direction.
7. The App shows a consumption value much higher than I would expect.	a. Change the Mains CT clamp (yellow label) orientation, by inverting the green dot (or the arrow direction inside the clamp) to the opposite direction. b. Ensure that the Mains CT clamp (yellow label) is clamped over the Mains Live phase cable after the Mains Meter and before the Consumer Unit and/or any Henley Block. Failing to do so will not give an accurate measure of total consumption.



## ATTENTION

**DO NOT CONNECT THE SMART PLUG/SWITCH TO:**

- medical equipment: the involuntary deactivation can cause life-threatening situations
- devices that can cause damage, injury or fire in case of accidental activation (eg. irons)
- appliances that can be damaged by turning on / off frequently
- appliances that cannot be interrupted
- appliances that require a continuous current supply.

**ATTENTION:** Always seek advice from the manufacturer or user manual of the appliance if it is suitable to control via radio plug or timer.





**ATTENTION:** Be sure to configure the Smart Plug/Switch correctly, as per the instructions from specific appliance manufacturers.

## MANAGING APPLIANCES VIA ELIOS4YOU SMART OR RED-CAP ACCESSORY

- Open the Elios4You APP
- Press Menu Button  --> Red Cap --> Activate Red Cap --> Confirm

### SMART PLUG / SWITCH PAIRING

**ATTENTION:** When pairing devices for the first time, keep devices within close range to the Elios4you transmitter. The devices can then be moved around to required position after pairing is complete. The Smart Plug/Switch does not need to be close to the Wi-Fi router, as the Smart Plug/Switch communicates using ZigBee RF (directly to the Elios4you transmitter) and not through Wi-Fi.

- Verify that your smart device (smartphone/tablet) is within radio range of the Wi-Fi and/or Elios4you.
- Install the Plug/Switch to be paired to Elios4you.
- Make sure that the Plug/Switch is not paired with a network already (Red LED flashing), otherwise perform the disassociation before continuing (see manual for Smart Plug/Switch).
- Select Menu icon in the Elios4you App  App --> Red Cap --> Add Smart Plug.
- Carefully follow the Wizard in the Elios4you App.
- Once complete, go back to the Home Screen of the App  select the Consumption icon:  taking you to the Consumption Details page where you will see icons for the management of individual appliances .
- To modify the settings of individual Plug/Switch, select the corresponding icon 

**NOTE:** repeat the above procedure for the installation of additional Smart Plug/Switch.

**ATTENTION:** Within 1 minute of the pairing procedure, you will be able to see the Smart Plug/Switch state in the Elios4you App.

### DIFFERENT STATES OF THE SMART PLUG/SWITCH IN THE APP:

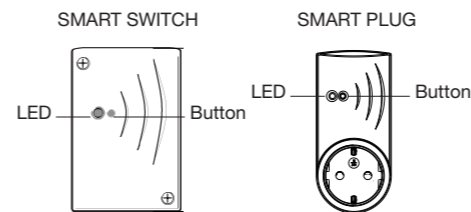

**GREY**  
Shows the OFF state (off) for both the manual mode and/or automatic mode.



**YELLOW**  
Shows the ON state (on) for both the manual mode and/or automatic mode.



**RED**  
Shows the OFFLINE state, meaning the plug/switch is off from the mains, or is out of radio range.

## TECHNICAL SPECS

<b>General Characteristics</b>	nr. 8 led of functionality diagnostic; Parameter configuration with Tablet
<b>Radio Characteristics</b>	Wi-Fi 802.11b; Access point (AP) Station (STA);B; Output Power 15 +- 1 dBm Red Cap (only Elios4you Smart); ZIGBEE Home Automation Profile (HA1.2) 2405 MHz ÷ 2480 MHz; IEEE 802.15.4 compatible; Nominal transmission Power +10dBm; Internal PCB Antenna
<b>Power Supply</b>	230Vac +- 20% 2 W
<b>Internal Memory</b>	Historical data up to two months with sampling every 15 minutes
<b>Alarms</b>	External alarm: free contact connected to the inverter or auxiliary contact breakers; Lack of production in absence of data after 4 hours in the central time zone (from 10.00 to 14.00)
<b>Connections</b>	Screw terminals for 230 V ac; Screw terminals for CT; Screw terminals for signal input alarm
<b>Dimensions of C.T. hole</b>	Internal diameter: 16 mm
<b>Antenna</b>	Wi-Fi external antenna SMA RP connector.
<b>Environment Parameters</b>	Operating temperature 0 + 50°C; International Protection IP45
<b>CE Declarations of Conformity</b>	Compliant with directives 2004/108 CE (Directive EMC) 2006/95 CE (Low Voltage Directive)/ 99/5 CEE (Radio Equipment Directive). Standards and/or technical specifications applied: ETSI EN 300 328v1.8.1:2012-06; ETSI EN 301 489- 17v2.2.1:2012; ETSI EN 301 489-1v1.9.2:2011; EN 61326-1:2013; EN 60950-1:2006 + A11 (2009)
<b>Dimensions (mm)</b>	